



GreenClad™ Insulated Façade System

TECHNICAL AND INSTALLATION MANUAL

Ver.3 Dt.12/04/2016

GreenClad INSULATED FAÇADE SYSTEM

CONTENTS

Introduction	Pg. 3
GreenClad Direct Fix System Options 1 & 2	Pg. 3 - 4
Physical Properties	Pg. 4
Standard panel sizes	Pg. 4
Density	Pg. 5
Weight	Pg. 5
Thermal performance - 'R' Value	Pg. 5
Moisture Resistance	
Design Criteria	Pg.6
Installation Design	Pg. 6
Structural Design & Weatherproofing	Pg. 6
Design conditions	Pg. 6
System Design - Frame, Panel Fixing Screw configuration – Table 4	Pg. 7
GreenClad System Overview - Installation & Coating-Figure 1	Pg. 8
Material and Specification List - EPS Panel Installation & Fixing	Pg. 9 -10
Material and Specification List – GreenClad Coating System	Pg. 11
Installation & Coating Guide	Pg. 12
GreenClad EPS Panel Installation & Fixing – Stage 1	Pg. 12 -13
GreenClad Coating System – Stage 2	Pg.14 to17
Health & Safety	Pg. 17
Installation & Fixing Details	
Ground Slab Edge Details	Pg. 18
Timber Floor Junction Details	Pg. 19
Roof Junction Details (option 1)	Pg. 20
Roof Junction Details (option 2)	Pg. 21
Vertical Expansion Joint Details	Pg. 22
Horizontal Expansion Joint Details	Pg. 23
EPS panel to Brick Wall details	Pg. 24
Corner Details	Pg. 25
Aluminium Frame Window Sill Details	Pg. 26
Timber Frame Window Sill Details	Pg. 27
Vertical Control Joint Details	Pg. 28
Eaves Detail	Pg. 29
Flush Eave Details	Pg. 30
Warranty	Pg. 31
Manufacturer's Comment	Pg. 31
Disclaimer	Pg. 31

Introduction

Description

GreenClad™ Insulated Façade system or GreenClad Direct Fix Cladding system is a reinforced lightweight insulated cladding system for use on exterior walls of buildings. Commonly referred to as Exterior Insulation and finishing systems (EIFS). It is made from “M” grade expanded polystyrene (EPS) moulded panels directly anchored to wall frame, coated and reinforced with an exterior GreenClad Coating System to give an exterior wall having a durable structure and weatherproof property. In this system, the EPS panels are directly anchored to the buildings wall frame

GreenClad Direct Fix EIFS Cladding System Attributes

- Structure Stability
- Thermal Insulation
- Weatherproofing
- Decorative exterior wall finish

GreenClad Direct Fix cladding system adds minimum weight to the structure and it contributes to the improvement of the building's energy efficiency by providing first stage insulation and weatherproofing, having good structural stability, thermal insulation and decorative exterior wall finish.

GreenClad Direct Fix System Options

GreenClad Direct Fix System has two panel options;

OPTION 1: Virgin EPS panel

Types;

1a. Plain EPS panel

1b. Vented EPS panel (panel with vented strips(groves), strips mounted vertically when fixed to wall frame and facing wall wrap, allows cavity to breath better in humid and wet conditions than Plain panels)

OPTION 2: Pre-Rendered EPS panel

(Pre-Rendered panel are factory coated with polymer-modified render and alkaline-resistant fibreglass mesh, ready to be anchored to frame and thereafter coated with only mesh on joints and not entire panel)

GreenClad Direct Fix System Application Summary

GreenClad™ panel are quickly and easily installed on timber or steel framed buildings as follows;

1. Virgin EPS Panel System specifications;

Important features

It consists of Plain and Vented EPS panels as stated above.

General Description

Virgin EPS panel are used in this system, panels are fastened and fixed directly on to timber or steel framed building having a Weatherproof Breathable Wall Wrap (Sarking) in between. Starter Channel Bead is fixed on to the bottom frame in required size. The panels are installed horizontally, and fastened directly into the studs using screws and plastic washers. The Panel joints are then sealed with PU Foam Adhesive, Corner angle beads are fixed and an Adhesive fibre glass mesh is stuck across the entire panel surface or mesh is embedded into the dry patch render and the panels are rendered and finished as per the GreenClad coating system consisting of two coats of polymeric render (base coat) and one coat of acrylic texture coat having a minimum coating thickness of 6mm.

GreenClad INSULATED FAÇADE SYSTEM

2. Pre-Rendered EPS Panel System specifications; Important features

It consists of Pre-Rendered EPS panel as stated above.

General Description

Pre-Rendered EPS panel is used in this system, panels are fixed directly on to the timber or steel framed building having a Weatherproof Breathable wall Wrap (Sarking) in between. Starter Channel Bead is fixed on to the frame in required size. The panels are installed horizontally, and fastened directly into the studs using screws and plastic washers. The Panel joints are sealed with PU Foam Adhesive, Corner angle beads are fixed and a 200mm fibreglass mesh is placed over panel joints only, the panels is rendered and finished as per the GreenClad coating system consisting of two coats of polymeric render (base coat) and one coat of acrylic texture coat having a minimum coating thickness of 6mm.

GreenClad System Overview

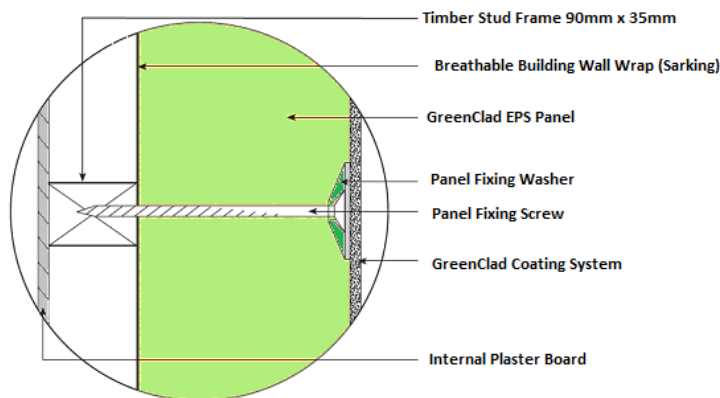

Physical Properties

The Physical properties of GreenClad™ EPS (Expanded Polystyrene) Panel comply with Australian Standard AS1366 Part 3-1992 for Rigid Cellular Polystyrene Moulded Class 'M' Grade (Medium Grade); it contains a flame retardant.

GreenClad EPS Panel Standard Sizes, Area and Thickness

GreenClad Direct Fix System 'M' grade EPS Panel Options 1 & 2	Size 1 - 1.2m x 2.4m Area - 2.88m ²		Size 2 - 1.2m x 4.8m Area - 5.76m ²	
	Wind Class	Panel Thickness	Wind Class	Panel Thickness
1a. Virgin Plain EPS panel	N1 & N2	50mm, 75mm, 100mm	N1,N2,N3,N4,N5, C1 & C2	75mm, 100mm
	N3, N4, N5, C1 & C2	75mm, 100mm		
1b. Virgin Vented EPS panel	N1, N2,N3,N4,N5, C1 & C2	75mm, 100mm	NA	NA
2. Pre-Rendered EPS panel	N1 & N2	50mm, 75mm, 100mm	NA	NA
	N3, N4, N5, C1 & C2	75mm, 100mm		
Manufacturing Tolerances Length: 2400mm & 4800mm ± 10mm Width: 1200mm ± 5mm, Thickness: ± 1.0mm				

GreenClad INSULATED FAÇADE SYSTEM

Density

Table 2: EPS Panel Density (polystyrene panel)

GreenClad EPS Panel Grade	Density
'M'	19 Kg/m ³

Standard Panel Weights

Table 1: Nominal Surface Mass and Weight of Option 1: Virgin Plain and Vented EPS Panel

GreenClad™ EPS Panel	Surface Mass @Kg/m ²	Panel Weight	Panel Weight
		1.2m x 2.4m - Area-2.88m ² Kg	1.2m x 4.8m - Area-5.76m ² Kg
50mm(plain only)	0.9	2.58	NA
75mm	1.32	3.80	7.60
100mm	1.73	4.98	9.96

Table 1A: Nominal Surface Mass and Weight of Option 2: Pre-Rendered EPS Panel

GreenClad™ EPS Panel	Surface Mass @Kg/m ²	Panel Weight
		1.2m x 2.4m – Area 2.88 m ² @Kg
75mm	2.9	8.4
100mm	3.4	9.8

Thermal Insulation & Performance

An 'R' Rating is achieved to the finished and coated GreenClad™ wall system as well as uncoated GreenClad™ EPS Panels. The 'R' value is a measure of thermal resistance; it is expressed as a thickness of the material divided by thermal conductivity (reference table 3).

The opportunity exists to accomplish higher 'R' ratings through the optional thicknesses of the panel, but without the need to apply additional materials.

Table 3: R values of GreenClad system uncoated and coated panels

GreenClad EPS Panel Thickness	Thermal conductivity at 23°C - W/mK	'R' Value at 23°C - m ² .K/W Uncoated Panel	'R' Value at 23°C - m ² .K/W Finished & Coated panel
50mm	0.0380	1.33	1.76
75mm	0.0380	2.00	2.46
100mm	0.0380	2.67	3.11

Moisture Resistance

GreenClad™ Direct Fix cladding system can provide a weatherproof face to a building, when correctly installed with GreenClad™ Breathable Wall Wrap (Sarking) and finished with the proper detailed flashings across all openings and coated with the approved GreenClad Coating System.

The coated GreenClad™ panels are water resistant, though panel material allows for the transmission of water vapour. This means the external face of a building is allowed to 'breathe'.

GreenClad INSULATED FAÇADE SYSTEM

Design Criteria

Installation Design

Installation and fixing requirements must – without exception – be in accordance with details stipulated in the manual and as per the requirements of the local building authority and currently prevailing Building codes as per current National Construction Code (NCC) and Building Code of Australia (BCA) requirements’.

Frame structure

The frame structure must be built in accordance with the Building Code of Australia (BCA) and with the relevant Australian Standards, for instance, AS 1684-2006 for Timber Frame.

Steel Frame must be constructed as per AS 3623-1993 and AS/NZS 4600-2005 (Cold formed steel structures) constructed in accordance with NASH Standard for Residential and Low-rise Steel Framing

Structural Design & Weatherproofing

GreenClad Direct Fix EIFS System, structural design and weatherproofing performance was evaluated in accordance through tests performed as follows;

References to Application Standards & Tests

Structural

AS 1170.2:2011	Structural Design Actions Part 2: Wind Actions
AS 1562.1:1992	Design and Installation of sheet roof and wall cladding
AS 4055 - 2012	In accordance to AS/NZS 4284:2008, Testing of Building Façades at test pressures nominated in AS 4055 - 2012 “Wind Loads for Housing”
AS 4040.5:1996	Resistance to impact (sandbag) for wall boards

Weatherproofing

AS/NZS 4284:2008	Testing of building facades (water penetration by static and cyclic pressures)
------------------	--

Thermal & Energy

AS1366 Part 3-1992	Rigid Cellular Polystyrene Moulded Class ‘M’ Grade (Medium Grade)
--------------------	---

Design Conditions

- For fixing of windows in external walls, these must satisfy BCA Volume 2 DtS provision 3.6.0 & AS 2047—1999; Windows in buildings— Selection and installation.
- Eaves and soffit linings must satisfy BCA Volume 2 DtS provision 3.5.3.5.
- Flashings to wall openings must satisfy BCA Volume 2 DtS provision 3.5.3.6.
- Windows must satisfy BCA Volume 2 DtS provision 3.6.0 & AS 2047—1999; Windows in buildings— Selection and installation.

Performance Requirement BCA Vol2 - P2.3.4 Bushfire areas

- GreenClad Cladding Systems satisfies the BCA Deemed-to-Satisfy Provisions only for external walls on sites up to BAL-19 and as described in AS3959-2009.

GreenClad INSULATED FAÇADE SYSTEM

Table 4 : GreenClad Direct Fix System Design – Frame & Panel Fixing Screw Configuration

Applicable for Panel Options 1 & 2

- Supporting frame structure – Timber frame and stud size - 90mm x 35mm and to be constructed as per AS 1684:2006 for Timber frames.
- Galvanised Bracings should be installed on frames as per standards.
- Steel Frame must be constructed as per AS 3623-1993 and AS/NZS 4600-2005 (Cold formed steel structures) constructed in accordance with NASH Standard for Residential and Low-rise Steel Framing.
- Weatherproof Breathable Wall Wrap (Sarking) must be installed on frame before anchoring panels.

GreenClad Direct-Fix panel selection and anchor-screw spacing as per AS 4055 Wind Loads for housing
Wind Classification - N1, N2, N3, N4 & N5 for Non-Cyclonic Regions A & B
Wind Classification - C1 & C2 for Cyclonic Region C & D

Stud spacing (max)			600mm	
Vertical Screw spacing (max)			300mm	
Wind Classification	GreenClad Virgin & Pre-Rendered 'M' Grade EPS panel	Panel Location	Vertical Screw spacing	No. of Screws per 1.2m x 2.4m panel
	Thickness			
N1, N2	50mm 75mm 100mm	Above 1.2m from corners	300mm	25 (or 5 per stud)
		Within 1.2m of wall corners	240mm	30 (or 6 per stud)
N3, N4, N5 and C1, C2	75mm 100mm	Above 1.2m from corners	300mm	25 (or 5 per stud)
		Within 1.2m of wall corners	240mm	30 (or 6 per stud)

**Noggins must be fixed/nailed to studs staggered up down by about 50mm at max 1200mm height*

Edge Fixing Requirements

When the panel is laid horizontally fix screw and washer 50mm from the top and 50mm from the bottom edge of the sheet to centre of screw at maximum of 600mm stud spacing

Panel Fixing Screw and Washer - Each fastener comprises: 1 Screw & 1 Washer

Screw:

- Class 3 screw for general, mild industrial and marine environment - further than 1km from coastal area
- Class 4 screw for severe marine environment – further than 100m and less than 1km from coastal area
- Grade SS 304 or SS 316 stainless steel for applications within 100m of breaking surf

GreenClad Virgin & Pre-Rendered EPS Panel Thickness	Panel fixing Screw Timber Frame Size	Fastener Screw Steel Frame	Starter Channel Bead Sizes
50mm	10G x 75mm Bungle head Class 3 or Class 4 or SS	10G x 65mm Wing Tek Class 3 or Class 4	50mm x 2.5m
75mm	10G x 100mm Bungle head Class 3 or Class 4 or SS	10G x 90mm Wing Tek Class 3 or Class 4	75mm x 2.5m
100mm	10G x 125mm Bungle head Class 3 or Class 4 or SS	10G x 115mm Wing Tek Class 3 or Class 4	100mm x 2.5m
Washer	Plastic Washer - 48mm diameter (UV stable)		

GreenClad INSULATED FAÇADE SYSTEM

GreenClad Direct Fix System Overview – Installation & Coating - Figure1

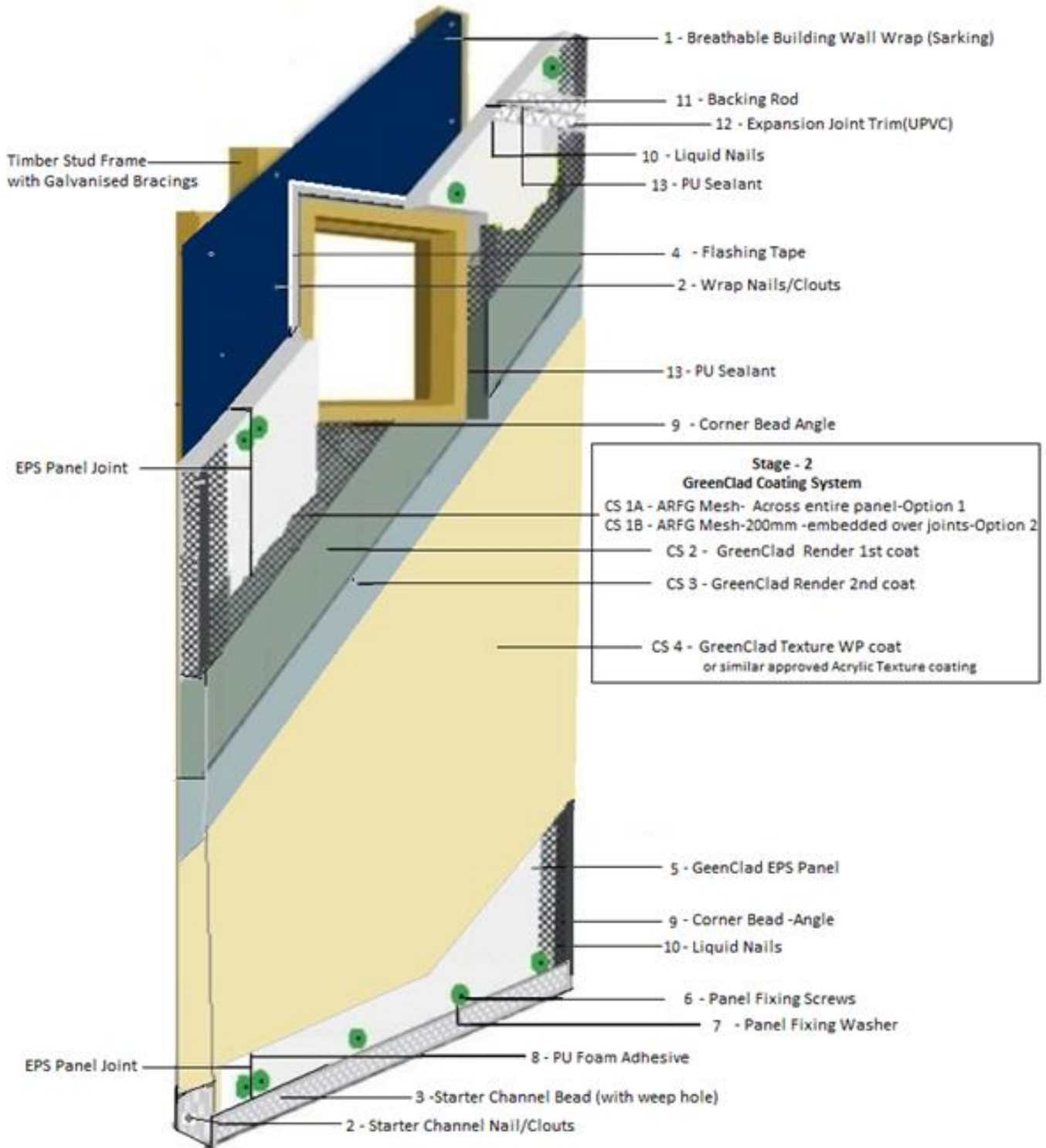

GreenClad INSULATED FAÇADE SYSTEM

GreenClad Direct Fix System Overview – Installation & Coating Material and Specification List - Refer Figure 1

Stage 1- EPS Panel Installation & Fixing																
Sr No.	Item - Description	Specification/Size														
1	Weatherproof Breathable Wall Wrap(Sarking)	<p>Use: For creating weatherproofing and moisture barrier around wall frame</p> <ul style="list-style-type: none"> Heavy Duty –AS/NZS 4200.1 Sizes: 1.35m X 36.5 & 2.74m X 30.0m <p>Wrap must overlap min 75mm on horizontal joints and 125mm on vertical joints, joints must be sealed with self-adhesive flashing tape to prevent water ingress.</p>														
2	Nails / Clouts	<p>Use: For fixing Wall Wrap, Starter Channel Bead, holding Corner angle bead</p> <ul style="list-style-type: none"> Galvanised Steel Flat Head Nails Size: 2.8mm x 40mm, 														
3	Starter Channel Bead	<p>Use: To seal bottom of panel and drain any entrapped moisture via weep holes. <i>For Size Selection refer Table 4 above</i></p> <ul style="list-style-type: none"> Aluminium channel, with weep holes Sizes: 50mm, 75mm, 100mm in 2.5m Lengths 														
4	Flashing Tape	<p>Use: Aluminium bituminous self-adhesive flashing tape for weatherproofing around all window rams' including sills, doors, openings, penetrations, intersections, connections, heads and jambs - and building wrap to be sealed with tape at all joints and opening, all of which must be flashed prior to panel installation</p> <ul style="list-style-type: none"> Aluminium / Bitumen self adhesive tape, flashing tape to comply with AS 2904 – 1995 Sizes: 75mm x 50m & 100mm x 50m Roll 														
5	GreenClad EPS Panel	<p>Use: Wall cladding panel</p> <table border="1"> <thead> <tr> <th rowspan="2">GreenClad Direct Fix 'M' grade EPS Panel Option 1 & 2</th> <th>Size 1 - 1.2m x 2.4m Area - 2.88m²</th> <th>Size 2 - 1.2m x 4.8m Area – 5.76m²</th> </tr> <tr> <th>Panel Thickness</th> <th>Panel Thickness</th> </tr> </thead> <tbody> <tr> <td>1a: Virgin Plain</td> <td>50mm, 75mm , 100mm</td> <td>75mm , 100mm</td> </tr> <tr> <td>1b: Virgin Vented</td> <td>75mm, 100mm</td> <td>NA</td> </tr> <tr> <td>2: Pre-Rendered</td> <td>50mm, 75mm , 100mm</td> <td>NA</td> </tr> </tbody> </table>	GreenClad Direct Fix 'M' grade EPS Panel Option 1 & 2	Size 1 - 1.2m x 2.4m Area - 2.88m ²	Size 2 - 1.2m x 4.8m Area – 5.76m ²	Panel Thickness	Panel Thickness	1a: Virgin Plain	50mm, 75mm , 100mm	75mm , 100mm	1b: Virgin Vented	75mm, 100mm	NA	2: Pre-Rendered	50mm, 75mm , 100mm	NA
GreenClad Direct Fix 'M' grade EPS Panel Option 1 & 2	Size 1 - 1.2m x 2.4m Area - 2.88m ²	Size 2 - 1.2m x 4.8m Area – 5.76m ²														
	Panel Thickness	Panel Thickness														
1a: Virgin Plain	50mm, 75mm , 100mm	75mm , 100mm														
1b: Virgin Vented	75mm, 100mm	NA														
2: Pre-Rendered	50mm, 75mm , 100mm	NA														
6	Panel Fixing - Screw	<p>Use: To anchor panels to stud frame, used with washer <i>For Screw Size selection and Quantity refer Table 4 above</i></p> <ul style="list-style-type: none"> Screw Sizes: <table border="1"> <tbody> <tr> <td>50mm EPS panel - 10G x 75mm Bungle head, Class 3 , Class 4 or SS</td> </tr> <tr> <td>75mm EPS panel - 10G x 100mm Bungle head Class 3 , Class 4 or SS</td> </tr> <tr> <td>100mm EPS panel -10G x 125mm Bungle head Class 3 , Class 4 or SS</td> </tr> </tbody> </table> Class 3 screw for general, mild industrial and marine environment - further than 1km from coastal area Class 4 screw for severe marine environment – further than 100m and less than 1km from coastal area. Grade SS 304 or SS 316 stainless steel for applications within 100m of breaking surf. 	50mm EPS panel - 10G x 75mm Bungle head, Class 3 , Class 4 or SS	75mm EPS panel - 10G x 100mm Bungle head Class 3 , Class 4 or SS	100mm EPS panel -10G x 125mm Bungle head Class 3 , Class 4 or SS											
50mm EPS panel - 10G x 75mm Bungle head, Class 3 , Class 4 or SS																
75mm EPS panel - 10G x 100mm Bungle head Class 3 , Class 4 or SS																
100mm EPS panel -10G x 125mm Bungle head Class 3 , Class 4 or SS																

GreenClad INSULATED FAÇADE SYSTEM

GreenClad Direct Fix System Overview – Installation & Coating

Material and Specification List - Refer Figure 1

Sr No.	Item - Description	Specification/Size
7	Panel Fixing - Washer	<p>Use: To anchor panels to stud frame, used with screws</p> <ul style="list-style-type: none"> Plastic (UV stable) Size: 48mm Diameter
8	PU Foam Adhesive	<p>Use: For sealing panel joints (panel to panel) and panel to other building elements, (flashing tape is applied to seal and waterproof joints)</p> <ul style="list-style-type: none"> Fishers or equivalent - Poly Urethane Expanding Foam Adhesive - 750ml Canister Fishers - Gun Cleaner Solvent Gun applicator
9	Corner Angle Bead	<ul style="list-style-type: none"> Aluminium - 32mm x 32mm x 2.7m or 3m Length for Virgin panels Aluminium with Mesh - 75mm x 125mm for Pre-Rendered panels Stainless Steel - 32mm x 32mm for Severe marine environment
10	Construction Adhesive (Liquid Nails)	<p>Use: Construction adhesive for fixing corner bead and expansion trim</p> <ul style="list-style-type: none"> SikaBond (Construction Adhesive) or Selleys Liquid (nail fast set only) Size: 300g cartridge
11	Backing Rod	<p>Use: Expansion joint filler</p> <ul style="list-style-type: none"> Polyurethane – 10mm dia X 210 lm
12	Expansion Joint Trim (UPVC)	<p>Use: Expansion joint trim</p> <ul style="list-style-type: none"> Plastic Expansion Joint Trims – UPVC 3m length
13	PU Sealant	<p>Use: Sealant to be used around the windows, doors & Expansion joints Minimum 8mm to max 10mm tolerance to be considered</p> <ul style="list-style-type: none"> TREMstop PU Sealant (Polyurethane paintable Sealant), Sikaflex-Pro or equivalent 600mL Sausage
14	Damp Proof course	<p>Use: Waterproofing between concrete slab and panel system</p> <ul style="list-style-type: none"> Bitumen PE Roll (as per AS2904-1995) Sizes: 110mmx 20m & 300mmx 20m Roll

GreenClad INSULATED FAÇADE SYSTEM

GreenClad Direct Fix System Overview – Installation & Coating Material and Specification List - Refer Figure 1

Stage 2 – GreenClad Coating System(CS)		
OPTION 1 - Direct Fix Virgin EPS Panel (Plain & Vented)		
Sr No.	Item - Description	Specification / Sizes
CS1A	GreenClad Panel Reinforcing Mesh	<p>Reinforcing Mesh – Two options;</p> <p>1. Pasted Alkaline Resistant Fibre Glass Mesh (ARFG) Adhesive Mesh</p> <ul style="list-style-type: none"> Type: 10mm x 10mm – 160gsm Size: 1m Wd & 1.2m x 50m Roll <p>Mesh pasted across entire panel surface before application of Base coat (GreenClad render)</p> <p>2. Embedded - Alkaline Resistant Fibre Glass Mesh (ARFG) Non-Adhesive Mesh</p> <ul style="list-style-type: none"> Type: 5mm x 5mm – 160gsm Size: 1mWidth & 1.2mWidth x 50m Roll <p>Embedded into 1st coat of Base coat (GreenClad render) across entire panel surface</p>
CS2 1 st coat & CS3 2 nd coat	GreenClad Render (Product: Painttex Dry Patch)	<p><u>It is Mandatory to exclusively use this product only</u> Painttex Dry Patch - Base coat Render for GreenClad System</p> <ul style="list-style-type: none"> 2 coat application Minimum total thickness for 2 coats – 6mm Packing: 20Kg / Bag Coverage: 3.5 to 4 Sqm per bag @ 3.5-4mm thickness
CS4	GreenClad Acrylic Texture (Product: Painttex Acrylic Texture)	<p><u>Optional</u> Painttex Acrylic Texture or Similar Approved Acrylic Texture Product</p> <ul style="list-style-type: none"> Single coat application Packing: 15L Pail – in vast range of colours Coverage: Trowel - Med Grade – 12Sqm per pail
OPTION 2 - Direct Fix Pre - Rendered EPS Panel		
CS1B	GreenClad Pre-Rendered Panel Joint Mesh	<p>Joint Mesh</p> <ul style="list-style-type: none"> Applied on panel joints only –embedded on joints into 1st Render base coat Alkaline Resistant Fibre Glass Mesh (ARFG) Type: 5mm x 5mm – 160gsm Size: 200mm x 50m Roll
CS2 1 st coat & CS3 2 nd coat	GreenClad Render (Product: Painttex Dry Patch)	<p><u>It is Mandatory to exclusively use this product only</u> Painttex Dry Patch - Base coat Render for GreenClad System</p> <ul style="list-style-type: none"> 2 coat application Minimum total thickness for 2 coats – 6mm Packing: 20Kg / Bag Coverage: 3.5 to 4 Sqm per bag @ 3.5-4mm thickness

GreenClad INSULATED FAÇADE SYSTEM

CS4	GreenClad Acrylic Texture (Product: Painttex Acrylic Texture)	<u>Optional</u> Painttex Acrylic Texture or Similar Approved Acrylic Texture Product <ul style="list-style-type: none">• Single coat application• Packing: 15L Pail – in vast range of colours• Coverage: Med Grade – 12Sqm per pail
------------	---	---

GreenClad Direct Fix System – Installation & Coating Guide

Stage1 - EPS Panel Installation & Fixing

Supporting Timber Stud frame

Important instructions

- Timber Stud frame to be constructed as per AS 1684:2006 for Timber frames.
- Timber Stud frame to be constructed with 90mm x 35mm structural timber stud having a minimum stud spacing of 600mm and *Noggins must be fixed/nailed to studs staggered up down by about 50mm at max 1200mm height
- Galvanised Metal Angle Brace should be installed on frames as per AS 1684:2006.
- Steel Frame must be constructed as per AS 3623-1993 and AS/NZS 4600-2005 (Cold formed steel structures) constructed in accordance with NASH Standard for Residential and Low-rise Steel Framing.
- Prior to installing GreenClad EPS Panels, ensure that solid back blocks are installed as per approved building standards for installation of hot water systems, air-conditioning units, clothes lines, etc. Walls must be (\pm 5mm) for best results.
- Check all materials are present as per material list for EPS Panel Installation and Fixing - Stage 1 on page 7 & 8 above.
- Building workmanship must comply with relevant Building codes.
- Observe relevant construction site safety regulations prior to commencement of job.

1. Breathable Wall Wrap (Sarking)

- Weatherproof Breathable Wall Wrap (Sarking) must be installed on frame before anchoring panels. Breathable Wall Wrap (Sarking) must be fixed to all areas where GreenClad EPS Panels are being installed, directly on 90mm x 35mm timber stud frame using fixing nails/clouts with silver side of the wrap facing inwards towards stud frame. The wrap must be extended to the bottom edge and behind the entire starter channel bead.
- Wrap must overlap min 75mm on horizontal joints and 125mm on vertical joints, all joints must be sealed with self-adhesive flashing tape to prevent water ingress.
- The wrap must be evenly trimmed at window and door openings in the frame. Flashing tape must be used in areas around windows and doors for additional waterproofing.
- At roof junctions fix necessary roof flashings over the building wrap, and then run a flashing tape over the junction of the wrap and the flashing before fixing the starter bead.

2. Cutting of EPS panels

- For Pre-Rendered panels most accurate, clean and minimal mess cutting, it's recommended to use a diamond tipped masonry blade or fibre cement blade on a hand power saw.
- For Virgin - Plain and Vented panel, for cutting, a hand saw or hot knife can be used.

3. Starter Channel Bead

- For both options, 1. Virgin and 2. Pre-Rendered panels, starter channel bead is nailed to the timber bottom frame and panels are screwed directly to the stud frame via Breathable Wall Wrap (Sarking).
- Fix Starter Channel Bead according to panel size in 50mm, 75mm or 100mm.
- Starter beads must be installed a minimum of 30mm below the timber frame bottom plate.
- While fixing the starter bead ensure the clearance from ground level is 100mm or from the roof pitch is minimum 10mm.

GreenClad INSULATED FAÇADE SYSTEM

- Starter Channel Bead must be used at the bottom of the EPS Panels which act as a drip mould for moisture to escape as they have weep holes.

4. Installation of EPS panels

- GreenClad EPS Panels are generally installed horizontally, to install vertically an additional stud or back block would be required to be installed at vertical panel joints for fixing with screws and washers at maximum 300mm screw centre spacing.
- Back Blocking of Stud joints;
 - Where sheet sides or ends do not finish on a stud, solid back blocking must be installed to strengthen and align joints. Back blocks are cut from off cuts of stud material.
 - The back blocks can be placed aligned with the joint or placed at 300mm centres perpendicular to the joint. Back blocks are to be nailed securely to the frame.
- Slot the EPS panel into the Starter Channel Bead and align the panel to the starting corner of the Breathable Wall Wrap covered timber frame wall. Ensuring the panel is flat and in level to the timber frame, (with standard tolerances $\pm 5\text{mm}$) fix the required EPS panel with screw and washer to the Breathable Wall Wrap covered timber stud frame at maximum of 300mm centre spacing. Ensure screw heads and washers must be slightly recessed into surface of the panel to ensure there are no raised areas
- Screw and fix all the EPS Panels to the timber stud frame as mentioned above and ensure the joints have minimum gap between each sheets.
- All panel joints and corner junction must be glued together using PU Foam Adhesive. Use the gun applicator to inject the PU foam adhesive into the panel joint and corner gaps to glue the panels together, ensure all gaps have been properly filled up, the foam acts as an adhesive and sealant. On drying the excess spill of expanded foam can be cut off with a Stanley knife to flush surface with the EPS panel. *(EPS Panels are not to be glued to stud frame. This will allow the frame to expand and contract without stressing the external coating).*
- All large openings in panel for windows, doors and other penetrations should be filled with PU Expanding Foam and sealed with Aluminium Flashing Tape directly to the Wall Wrap (Sarking).

5. Vertical & Horizontal Expansion Joints

- It is mandatory to have vertical expansion joints every 5 to 6 metres where the wall is greater than 8 metres and the horizontal expansion joint must not exceed more than 3 metres or in special circumstances provide expansion joints as advised by the design engineer. It is also mandatory to have an expansion joint at the junction of the EPS Panel and other substrates like brick, concrete and other masonry substrates.
- Where expansion joints are present within the EPS panel wall, screw the Panels having a joint gap of 8-10mm between the two panels. Refer to details on vertical, horizontal expansion joint as shown in figure. Insert the Backing Rod into the expansion joint gap at 5mm from surface, glue the Expansion joint trim on the edge of both the EPS Panel using Liquid nails, hold with an adhesive tape until dry and remove the tape before coating with Render base coat and Texture. Do not cut the trim till the entire coating system has been applied. Ensure the expansion joint is not coated with either Render or Texture, after cutting the trim with a Stanley knife; fill the expansion joint with PU Sealant, flushed to the coated surface. Finally the sealant has to be coated with paint in required colour to match Texture coat.

6. Corner Angle Bead & Window Angle Sill bead

- Every external corner of the EPS Panels must be protected using Corner Angle Bead,
- For a smooth finish and a proper corner joint, mitre the corner angle bead with a cutter before installation
- Hold the corner beads to the EPS panels before rendering by either using galvanised clouts or glue using liquid nail (when using liquid nails hold with an adhesive tape till dry, remove the tape before render base coat is applied).
- Ensure when plain Corner Angles Beads are used, generally for EPS Virgin (Plain & Vented) panel, all un-meshed surface of the EPS panel on corner joint is covered by ARFG - Adhesive mesh.
- Ensure Corner Angles Bead with mesh is used for EPS Pre-Rendered panels; install the longer mesh side over the un-rendered side of the EPS panel corner joint area of the two EPS Panels when glued. Where windows and doors are present cut and fix the EPS Panels flush to the trims ensuring the EPS panel is cut at 90 deg along the side and top frame (Jamb) to fix the corner angle bead and all exposed panel surface covered with mesh, use angle bead with mesh on the bottom side of the window frame having the window sill EPS panel with a slope of minimum 10mm as per figure. Keep only required gap between the

GreenClad INSULATED FAÇADE SYSTEM

frame and the EPS Panel to accommodate for the coating and sealant as per details for aluminium window frame and timber window frame of this manual.

- Additional screws and washers can be used to fix the EPS Panels around the windows and door frames, all exposed EPS surface should be meshed, coat the panel as per coating system, fill the gap at the junction of the window and door frame and the coated panel with PU Sealant flushed to the coated surface. Finally the sealant has to be coated with paint in required colour to match Texture coat.

Parapet

- Metal flashing is the preferred recommendation for waterproofing and should be approved by the project consultant; refer to for preferred parapet detail. Where waterproofing is required, this should be in accordance with the project specification and project principal.

Balcony & Terraces

- Where waterproofing is required, this should be in accordance with the project specification and project principal.

Stage 2 - GreenClad Coating System

After the installation and fixing of the EPS Panels, the Panels have to be coated as per the GreenClad Coating System. AS FOLLOWS;

Prior to application of the coating system, refer to this manual and also ensure the following;

- The EPS Panel wall has been properly installed and prepared (setup) as specified in the EPS Panel Installation & Fixing guidelines- Stage1 above.
- Check all expansion joints, corner angle beads, window sill bead etc are in place.
- Remove all tapes and unwanted contaminants from the EPS panel surface.
- Check all materials are present as per material list for GreenClad Coating System on page 9 of this manual.
- Clean the surface and prepare the wall for the application of the GreenClad Coating System - Stage2, mask windows and doors and lay drop sheets.
- All surfaces to be coated must be clean, sound and free from contaminants including; oil, dust, dirt, silicone, mud, grease, animal droppings and any loose or flaking EPS material.
- Building workmanship must comply with relevant Building codes.
- Observe relevant construction site safety regulations prior to commencement of job.
- After installation, Virgin panels should be coated as soon as possible(within 14 days), this is to avoid UV degradation of exposed polystyrene surface to sun light causing yellowing and surface powdering, if this happens the surface has to be properly cleaned prior to application of GreenClad Coating system.

Important instructions

Control Joints (common for Option 1 & 2)

- Vertical control joints have to be formed on doors and windows as per details shown in Figure 12 of this manual. The joints have to be created after the coating of Render Base Coat has been completed and render has cured. Texture coat must not be applied over control joints. The joints can be formed by cutting a groove of minimum 5mm into the reinforced mesh render coating until the exposure of the EPS Panel using a concrete cutting disc. After creating a groove, all control joints have to be flush filled with PU Sealant flushed to the coated surface. Finally the sealant has to be coated with paint in required colour to match Texture coat.

Note* For Option 1 & 2 – Texture coat application is similar

OPTION 1 - Direct Fix Virgin EPS Panel (Plain & Vented panels)

Application:

Check the panels are installed as per stage1 and ready for coating Products: CS1A and CS2, CS3 and CS4 as per Option1 - page 9.

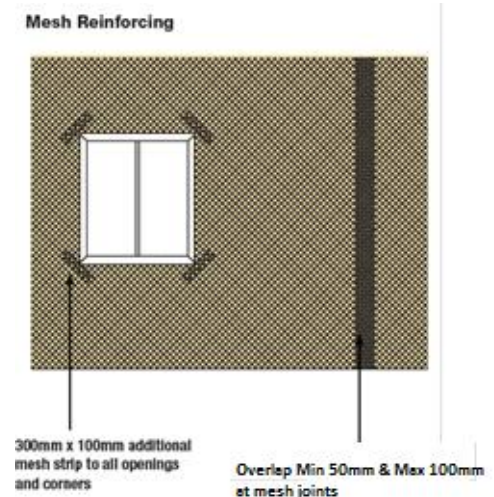

GreenClad INSULATED FAÇADE SYSTEM

Application of Panel Reinforcing Mesh (CS1A)

Type: –Pasted Alkaline Resistant Fibre Glass Adhesive Mesh

10mm x 10mm – 160gsm

- Apply/Paste Alkaline Resistant Fibre Glass Adhesive Mesh (CS1A) across the entire EPS panel surface, Panel joints must be evenly covered with the same mesh (avoid overlap of mesh joints near the main panel joint), ensure that the mesh pieces overlap by a minimum 50mm and maximum of 100mm at mesh joints (as shown in figure), apply enough pressure to stick the mesh evenly across the surface, no blister of the mesh should be present, if present, put a cut on the bulged mesh with a knife and press on to the panel, before application of render take care the entire EPS panel, all exposed corner surface are covered with adhesive mesh.
- Strips of adhesive mesh at 45° angle or equivalent, 300mm long by 150mm wide (as shown in figure), should be placed across the corner of all window and door openings.

Application of GreenClad Render Base Coat (CS2 & CS3)

Product: **Painttex Dry Patch (GreenClad Render) > *It is Mandatory to exclusively use this product only Refer to Dry Patch Technical data sheet & MSDS before application***

Packing: 20Kg / Bag

Coverage: 3.5 to 4 Sqm per bag @ 3.5-4mm thickness

- Mix one (1) 20kg bag of Painttex Dry Patch (CS2) to 3.5 - 4.5 litres of clean water, in a pail using a power stirrer, mix until the consistency is creamy and lump free. Allow the mix to stand for 5 minutes, remix before use or before adjusting consistency if required.
- Apply a 3-4mm basecoat of Painttex Dry Patch onto the panel using a steel trowel with enough pressure to adhere the product. On setting use a straight edge and screed surface, thereafter using a polystyrene float, finish the surface to give an even and level finish.
- When the first coat has firmed up (after 2-3 hrs), in the same sequence apply another coat of Painttex Dry Patch (CS3) at a thickness of 3-4mm. On setting use a straight edge and screed surface, thereafter using a polystyrene float, finish the surface to give an even and level finish.
- Painttex Dry Patch should be of minimum 6mm thick.
- Do not apply Patch over expansion joints.
- Allow 7 days to cure depending on the drying conditions prior to commencing the Texture coat.
- Painttex Dry Patch should be completely dry and hard before application of Texture coat.

Type: Embedded Alkaline Resistant Fibre Glass Mesh - Non Adhesive Mesh-

5mm x 5mm – 160gsm

- Mix one (1) 20kg bag of Painttex Dry Patch (CS2) to 3.5 - 4.5 litres of clean water, in a pail using a power stirrer, mix until the consistency is creamy and lump free. Allow the mix to stand for 5 minutes, remix before use or before adjusting consistency if required.
- Apply a 3-4mm basecoat of Painttex Dry Patch (CS2) onto the EPS panel surface using a steel trowel with enough pressure to adhere the product. Whilst the base coat is wet embed a full layer of alkali resistant 5mm x 5mm fibreglass mesh ensuring that the mesh pieces overlap by a minimum of 50mm to max 100mm at mesh joints. Panel joints should be evenly covered with the same embedded mesh (avoid overlap of mesh joints near the main panel joint). Strips of mesh at 45 degree angle or equivalent, 300mm long by 100mm wide, should be embedded across the corner of all window and door openings. On setting use a straight edge and screed surface, thereafter using a polystyrene float, finish the surface to give an even and level finish.
- When the first coat has firmed up (after 2-3 hrs.), in the same sequence apply another coat of Painttex Dry Patch (CS3) at a thickness of 3-4mm. On setting use a straight edge and screed surface, thereafter using a polystyrene float, finish the surface to give an even and level finish.
- Painttex Dry Patch should be of minimum 6mm thick.
- Do not apply Patch over expansion joints.
- Allow 7 days to cure depending on the drying conditions prior to commencing the Texture coat.
- Painttex Dry Patch should be completely dry and hard before application of Texture coat.

GreenClad INSULATED FAÇADE SYSTEM

Application of GreenClad Acrylic Texture (CS4)

Product: **Painttex Acrylic Texture** or Similar Approved Acrylic Texture Product > **Optional**

Refer to Texture Technical data sheet & MSDS before application

Packing: 15L Pail – in vast range of colours

Coverage: Med Grade – 12Sqm per pail

Before application, ensure render surface is cured, hard and dry;

- Mix thoroughly, Painttex Acrylic Texture pail (CS4) with a power mixer; confirm product colour and consistency before application.
- Generally applied with a steel trowel and finished off with a plastic float.
- Apply a skim coat of Texture (CS4) with a steel trowel along the dry and levelled rendered surface; apply 1 to 2 m² at a time.
- Allow the material to stand for a short time, thereafter use a plastic (PP) float in a circular fashion to level and produce the desired texture effect. Application must be in a brisk uniform fashion terminating when the whole area is complete, banded by a natural break such as an expansion and control joints, corner etc. Let the texture dry minimum for 24 hours@ 25DegC and 50%RH.
- Texture should not be extended (spread) too far; otherwise durability and hiding power may suffer.
- Texture surface should be protected from rain and extreme weather conditions till completely dry.

OPTION 2 - Direct Fix Pre - Rendered EPS Panel

Application:

Check the panels are installed as per stage1 and ready for coating

Products: CS1B and CS2, CS3 and CS4 as per Option2 - page 9.

Application of GreenClad Render Base Coat (CS2 & CS3) and Pre-Rendered Panel Joint mesh (CS1B)

Product: **Painttex Dry Patch (GreenClad Render)** > ***It is Mandatory to exclusively use this product only***

Refer to Dry Patch Technical data sheet & MSDS before application

Packing: 20Kg / Bag

Coverage: 3.5 to 4 Sqm per bag @ 3.5-4mm thickness

Panel Joint mesh

Type: 5mm x 5mm – 160gsm Alkaline resistant Fibre Glass Mesh

Size: 200mm x 50m Roll

- Mix one (1) 20kg bag of Painttex Dry Patch (CS2) to 3.5 - 4.0 litres of clean water, in a pail using a power stirrer, mix until the consistency is creamy and lump free. Allow the mix to stand for 5 minutes, remix before use or before adjusting consistency if required.
- Apply a 3-4mm basecoat of Painttex Dry Patch onto the Pre-Rendered EPS panel using a steel trowel with enough pressure to adhere the product. Whilst the basecoat is wet embed 200mm Mesh across panel joint only (160gm/m² (5mm x 5mm) fibreglass mesh). Strips of mesh at 45 degree angle or equivalent, 300mm long by 150mm wide, should be embedded across the corner of all window and door openings. On setting use a straight edge and screed surface, thereafter using a polystyrene float, finish the surface to give an even and level finish.
- When the first coat has firmed up (after 2-3hrs), in the same sequence apply another coat of Painttex Dry Patch (CS3) at a thickness of 3-4mm. On setting use a straight edge and screed surface, thereafter using a polystyrene float, finish the surface to give an even and level finish.
- Painttex Dry Patch should be of minimum 6mm thick.
- Do not apply Patch over expansion joints.
- Allow 7 days to cure depending on the drying conditions prior to commencing the Texture coat.
- Painttex Dry Patch should be completely dry and hard before application of Texture coat.

Application of GreenClad Acrylic Texture (CS4)

Product: **Painttex Acrylic Texture** or Similar Approved Acrylic Texture Product > **Optional**

Refer to Texture Technical data sheet & MSDS before application

Packing: 15L Pail – in vast range of colours

Coverage: Med Grade – 12Sqm per pail

Before application, ensure render surface is cured, hard and dry;

- Mix thoroughly, Painttex Acrylic Texture pail (CS4) with a power mixer; confirm product colour and consistency before application.
- Generally applied with a steel trowel and finished off with a plastic float.

GreenClad INSULATED FAÇADE SYSTEM

- Apply a skim coat of Texture (CS4) with a steel trowel along the dry and levelled rendered surface; apply 1 to 2 m² at a time.
- Allow the material to stand for a short time, thereafter use a plastic (PP) float in a circular fashion to level and produce the desired texture effect. Application must be in a brisk uniform fashion terminating when the whole area is complete, banded by a natural break such as an expansion and control joints, corner etc. Let the texture dry minimum for 24 hours @ 25DegC and 50%RH.
- Texture should not be extended (spread) too far; otherwise durability and hiding power may suffer.
- Texture surface should be protected from rain and extreme weather conditions till completely dry.

Health & Safety

To assist in maintaining a safe and healthy workplace, take note of the following:

- Refer to GreenClad Products Material Safety Data Sheet (MSDS)
- Use of personal protective equipment (face masks and safety goggles) is recommended. The fine dust created by mechanical cutting is hazardous, and protection is recommended, including face masks and safety goggles.
- Mechanical cutting should be performed in well-ventilated spaces.
- Power tools can be fitted with effective dust-extraction systems.



Storage, Handling, Protection

- **GreenClad** panels delivered to site should be stored flat and evenly supported. They should be covered or otherwise protected from UV, damage or soiling. If stored outside panel stacks are to be covered,
- During installation, the GreenClad panels should be handled with care to prevent edge damage or fracture.

GreenClad INSULATED FAÇADE SYSTEM

Installation & Fixing Details

Figure 2

Ground Slab Edge Detail

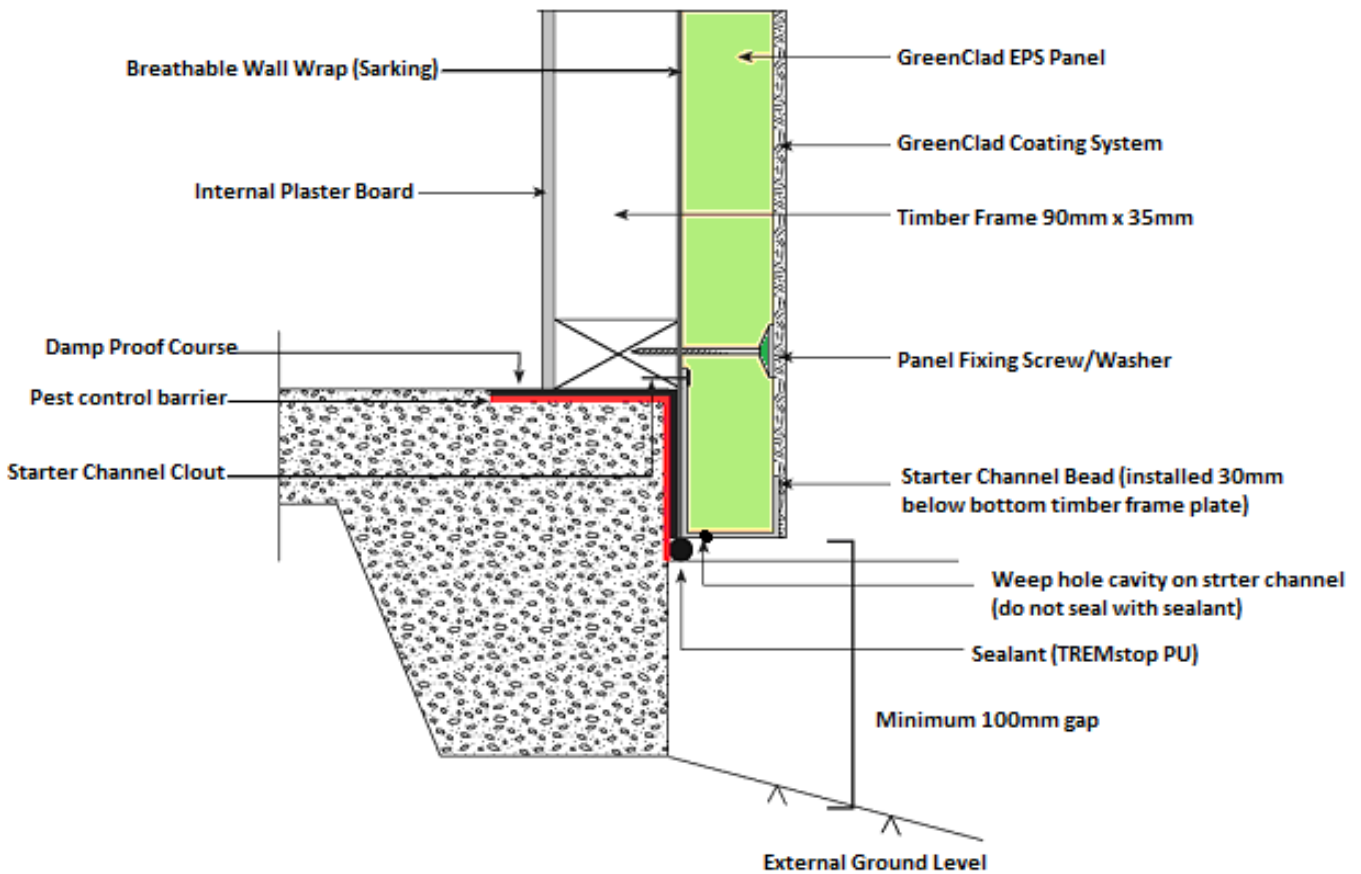

GreenClad INSULATED FAÇADE SYSTEM

Installation & Fixing Details

Figure 3

Timber Floor Junction Details

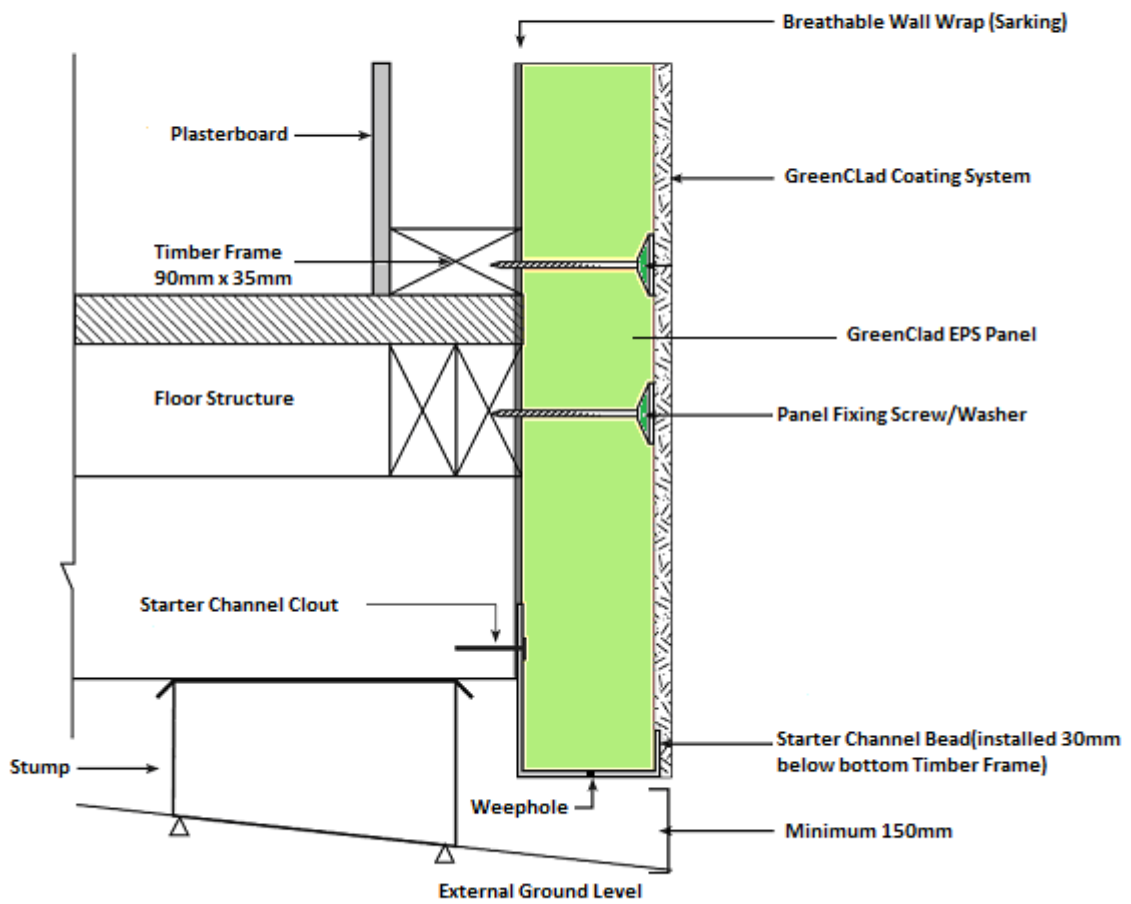

GreenClad INSULATED FAÇADE SYSTEM

Installation & Fixing Details

Figure 4

Roof Junction Detail (Option 1)

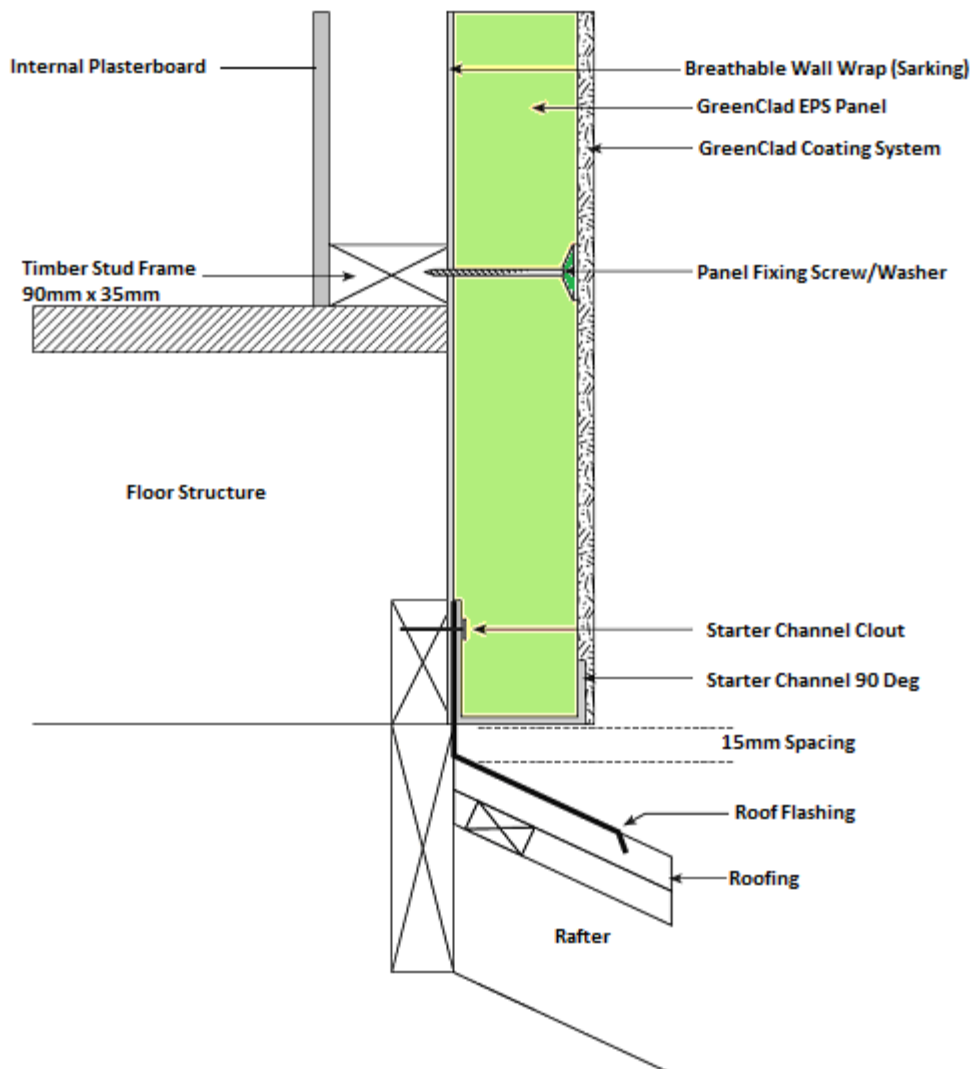

GreenClad INSULATED FAÇADE SYSTEM

Installation & Fixing Details

Figure 5

Roof Junction Detail (Option 2)

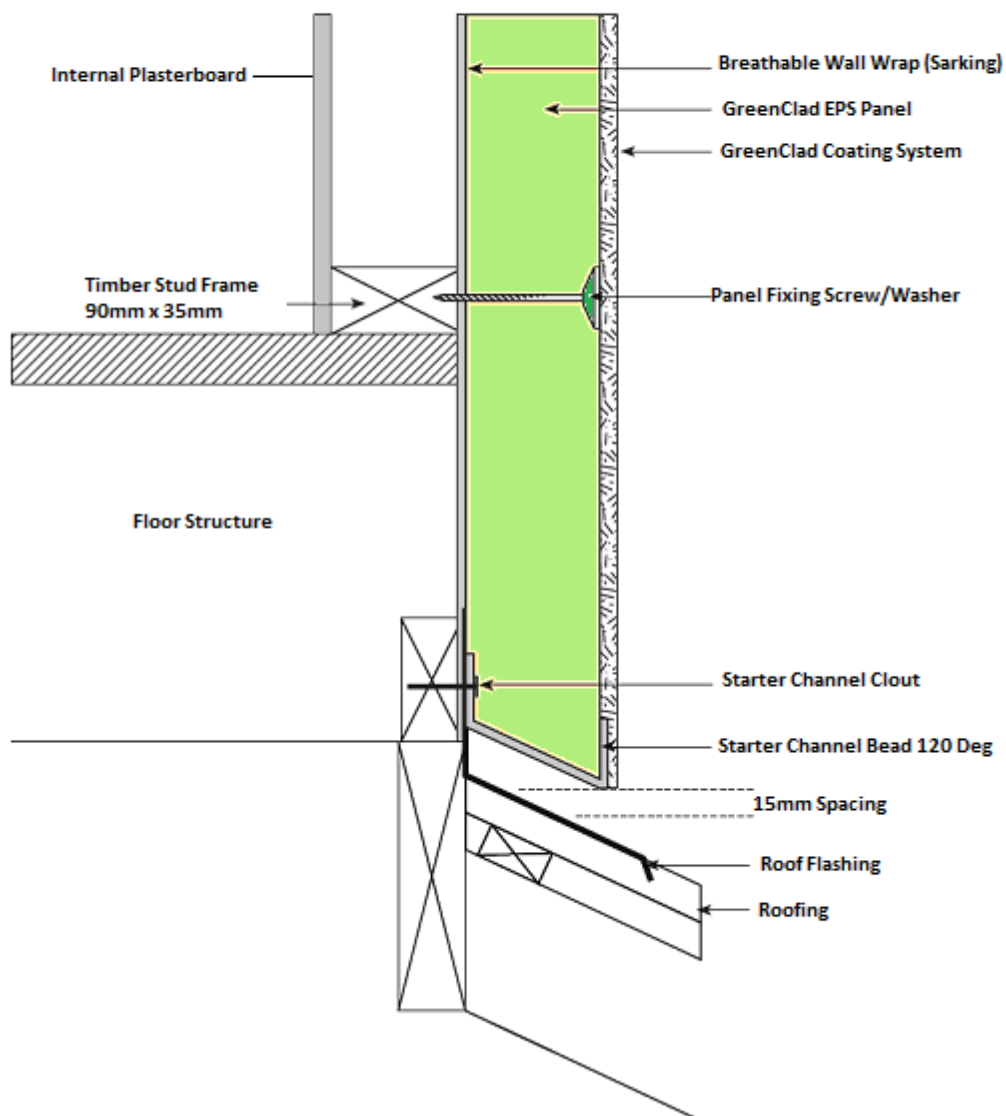

GreenClad INSULATED FAÇADE SYSTEM

Installation & Fixing Details

Figure 6

Vertical Expansion Joint Details

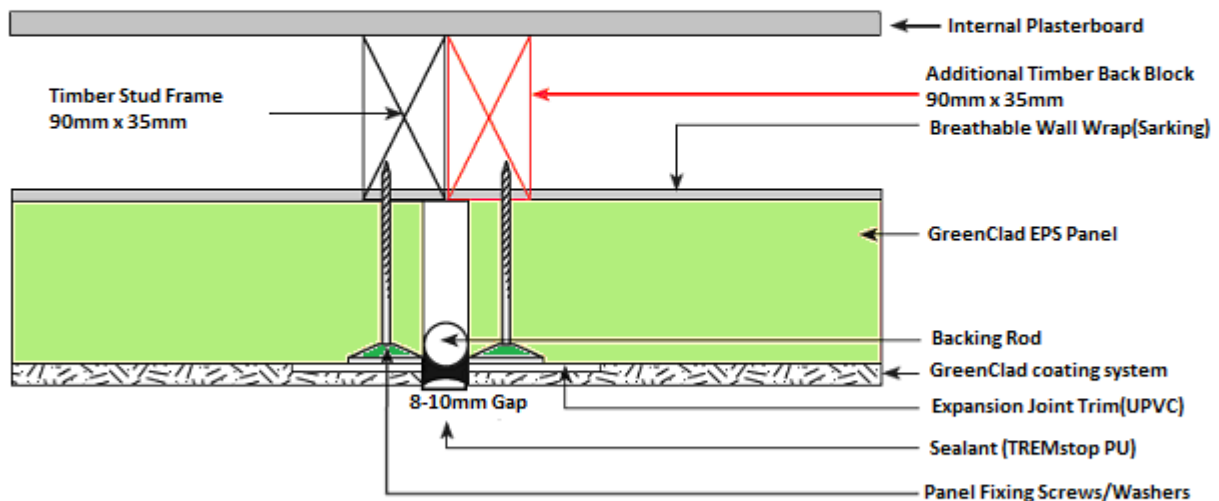

- Vertical Expansion Joints are to be at 5 to 6 metres.
- Insert Backing Rod into the gap.
- Fix Expansion Trim with Liquid Nails, complete render and texture coating, do not apply on trim.
- Slit the Expansion Trim and fill the gap with PU Sealant to flush with the texture surface before painting.

GreenClad INSULATED FAÇADE SYSTEM

Installation & Fixing Details

Figure 7

Horizontal Expansion Joint Details

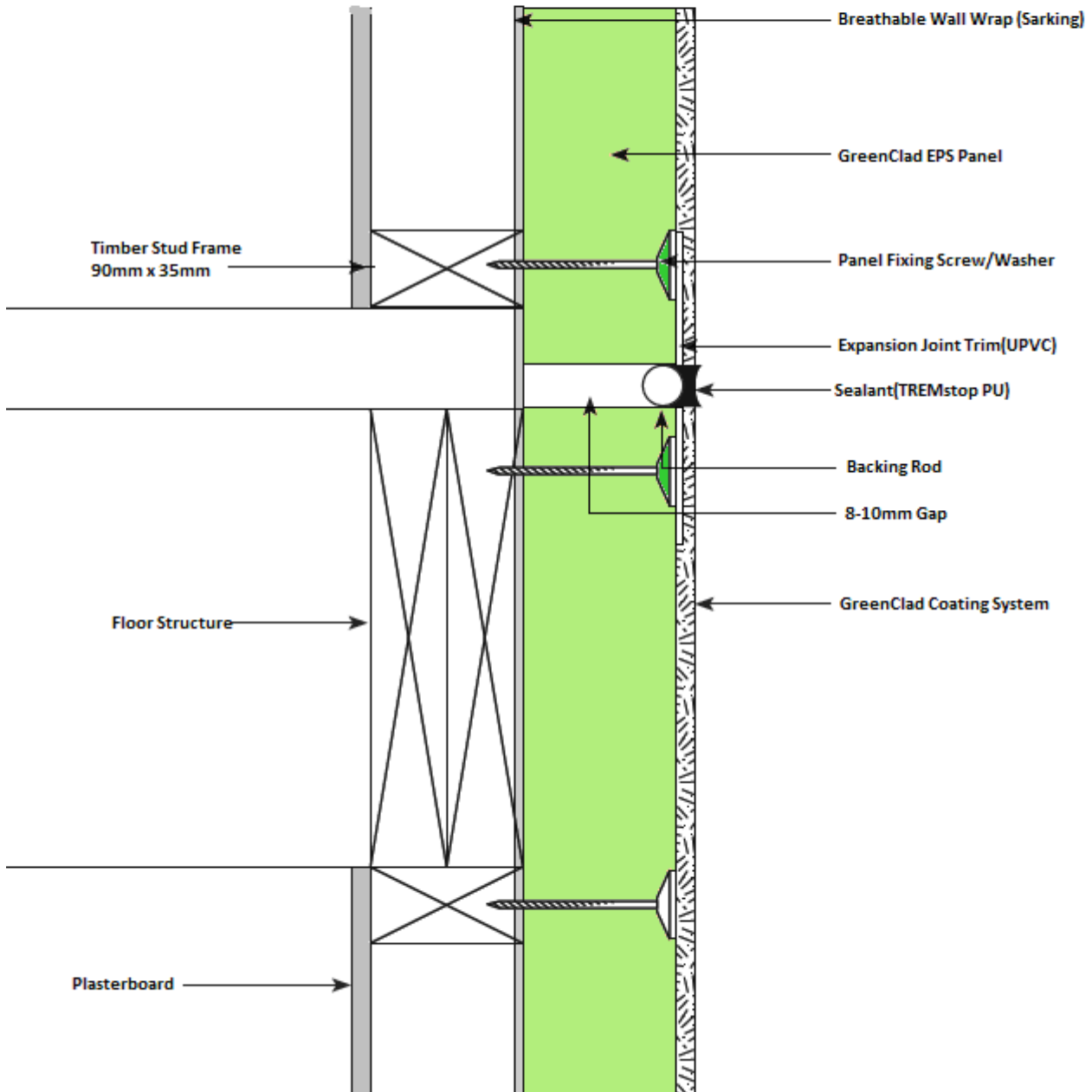

- Horizontal Expansion Joints are to be at 3 metres.
- Insert Backing Rod into the gap.
- Fix Expansion Trim with Liquid Nails, complete render and texture coating, do not apply on trim.
- Slit the Expansion Trim and fill the gap with PU Sealant to flush with the texture surface before painting.

GreenClad INSULATED FAÇADE SYSTEM

Installation & Fixing Details

Figure 8

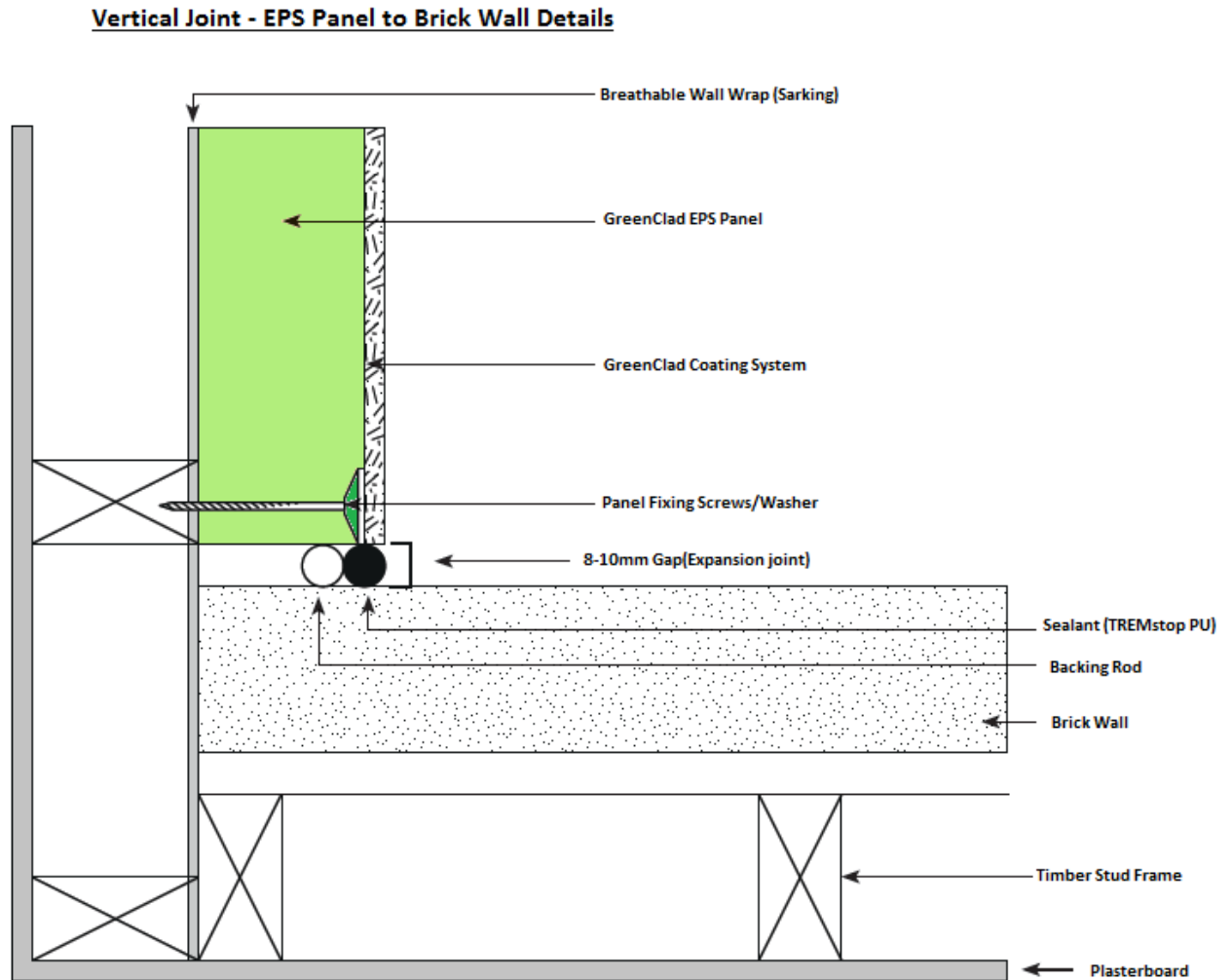

GreenClad INSULATED FAÇADE SYSTEM

Installation & Fixing Details

Figure 9

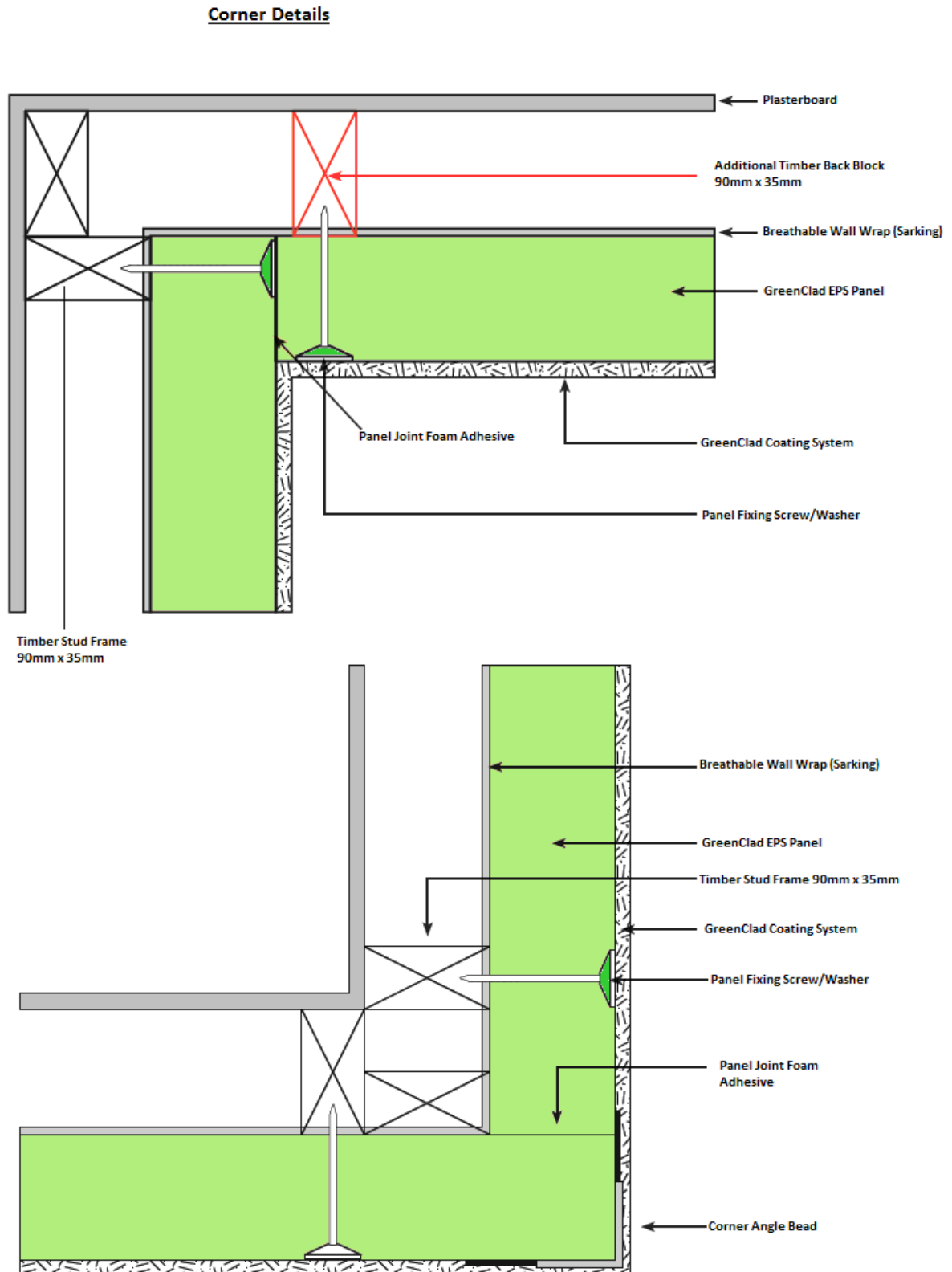

GreenClad INSULATED FAÇADE SYSTEM

Installation & Fixing Details

Figure 10

Typical Aluminium Frame Window Sill Detail

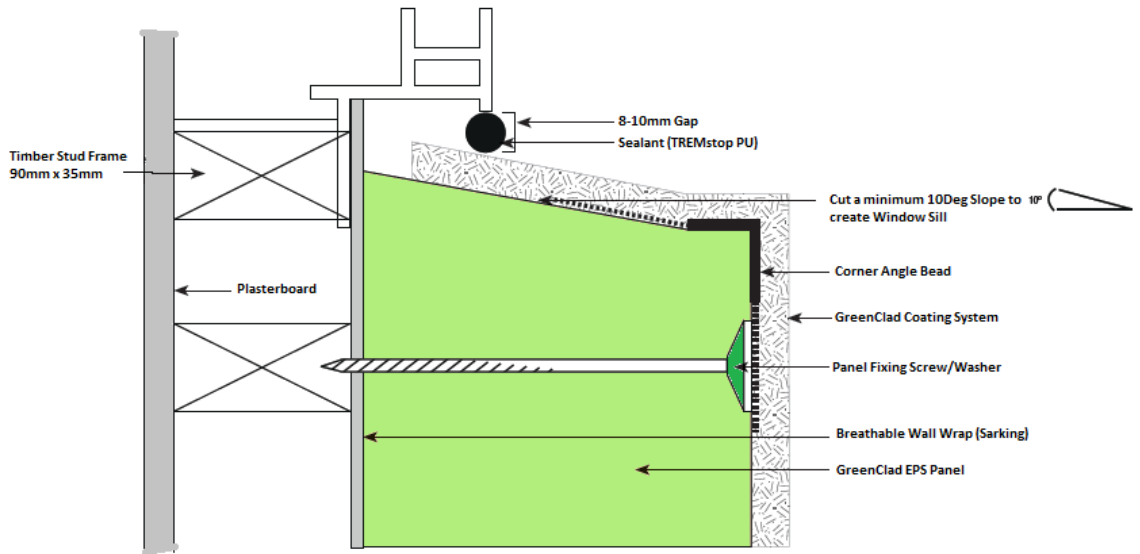

Typical Aluminium Frame Jamb Detail

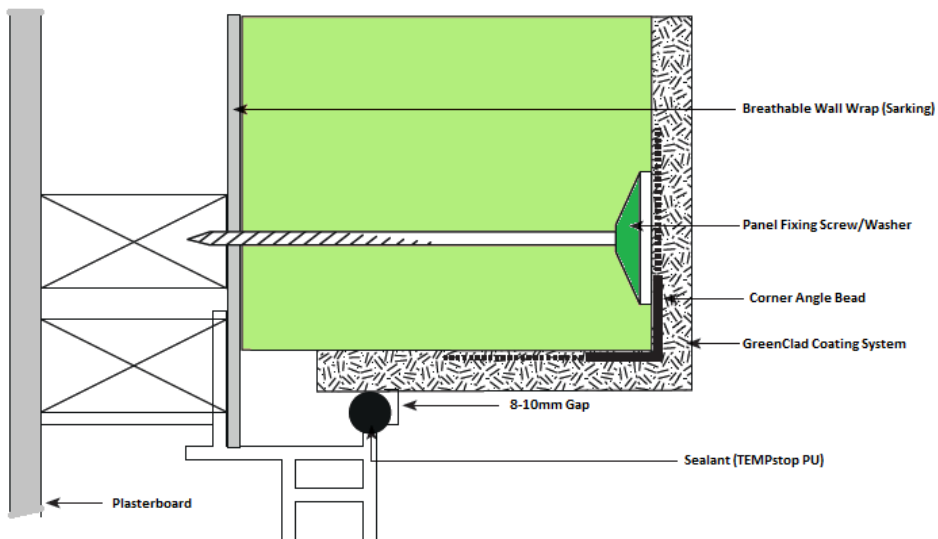

GreenClad INSULATED FAÇADE SYSTEM

Installation & Fixing Details

Figure 11

Typical Timber Window Sill Detail

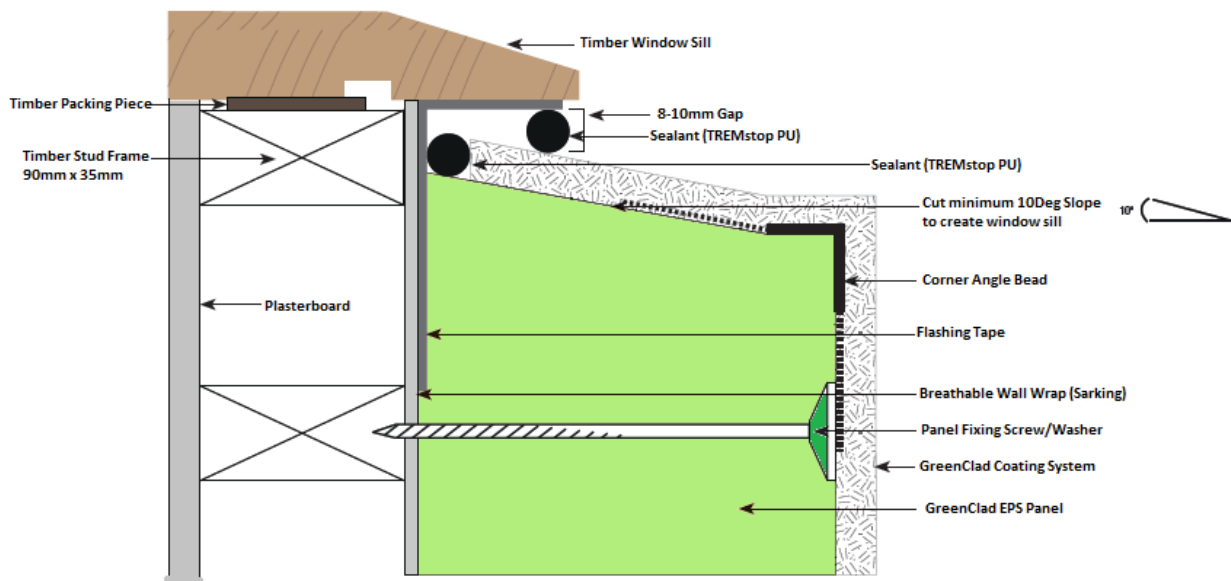

Typical Timber Window & Door Jamb Detail

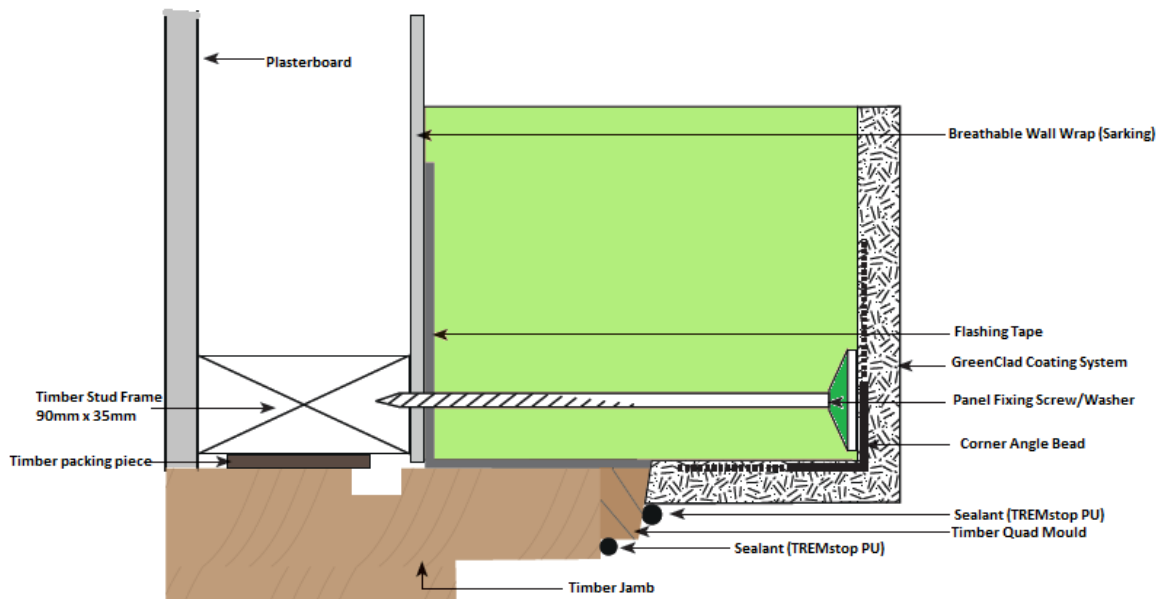

GreenClad INSULATED FAÇADE SYSTEM

Installation & Fixing Details

Figure 12

Vertical Control Joints

Vertical control joints should be created over Doors, Windows and Sliding Door Openings.

After GreenClad Render Base coat has completely cured, cut 5mm groove using a concrete cutting disc through the Base coat and mesh exposing the GreenClad panel. Complete the GreenClad Texture coat without coating the cut control joint. After Texture coat has dried fill flush all control joints with Sealant (TREMstop PU) and touch up sealant with paint in required colour to match Texture coat.

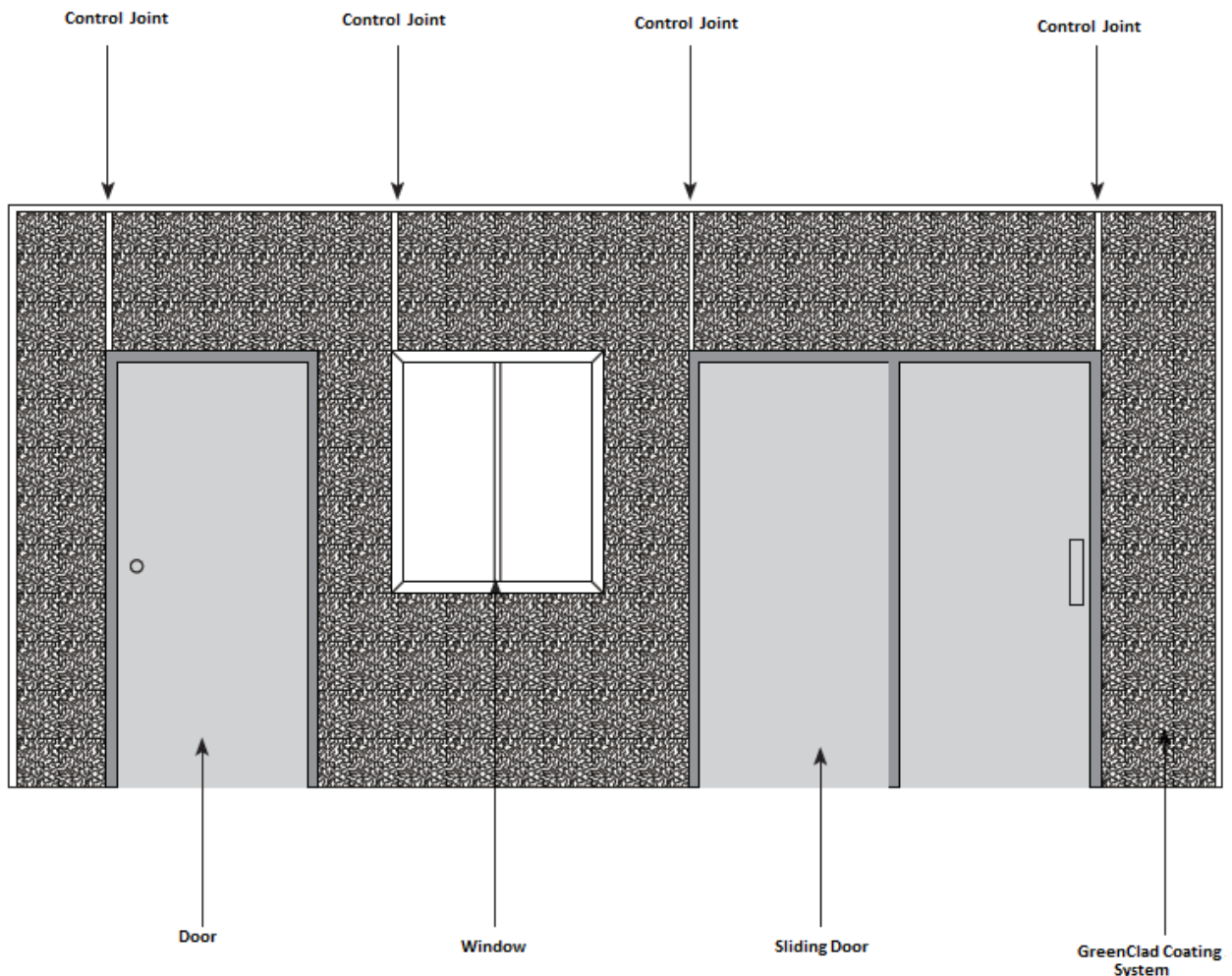

GreenClad INSULATED FAÇADE SYSTEM

Installation & Fixing Details

Figure 13

Eave Detail - Type 1 & 2

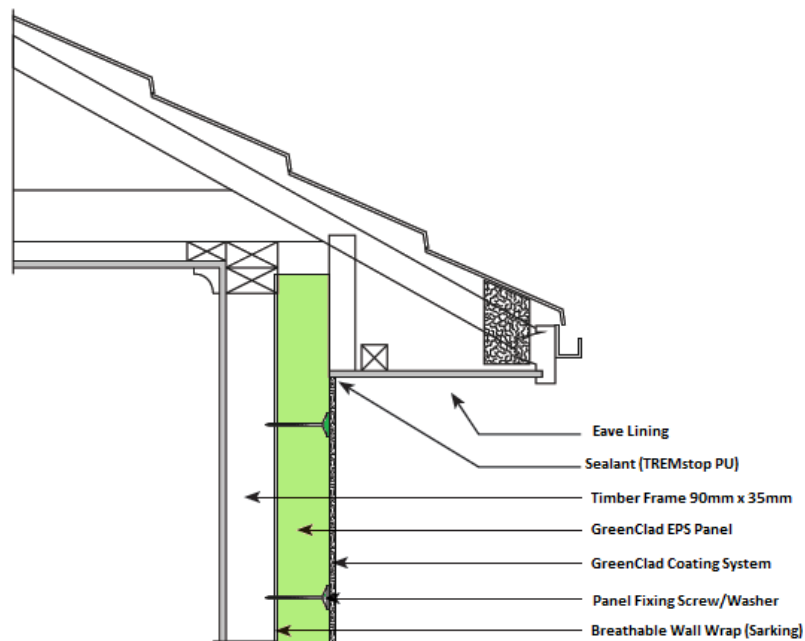
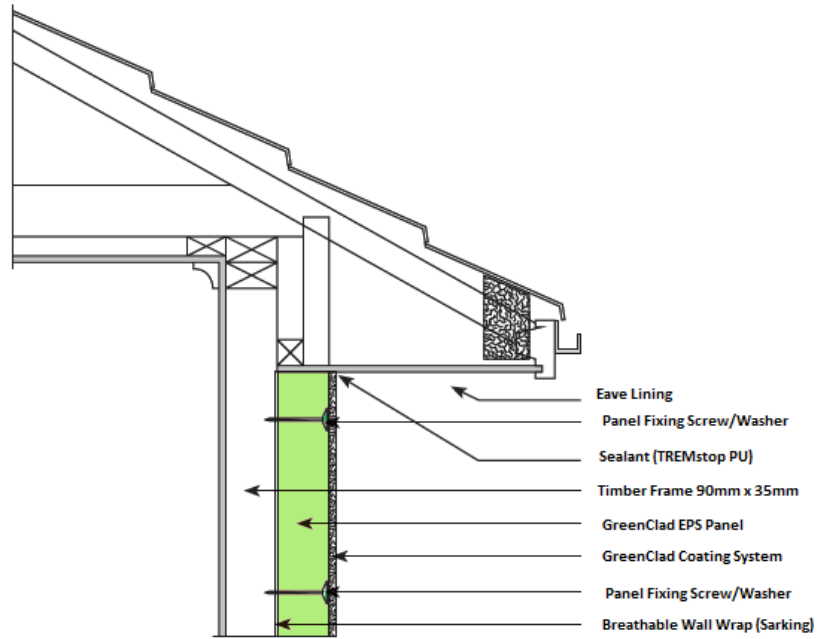

GreenClad INSULATED FAÇADE SYSTEM

Installation & Fixing Details

Figure 14

Flush Eave Detail

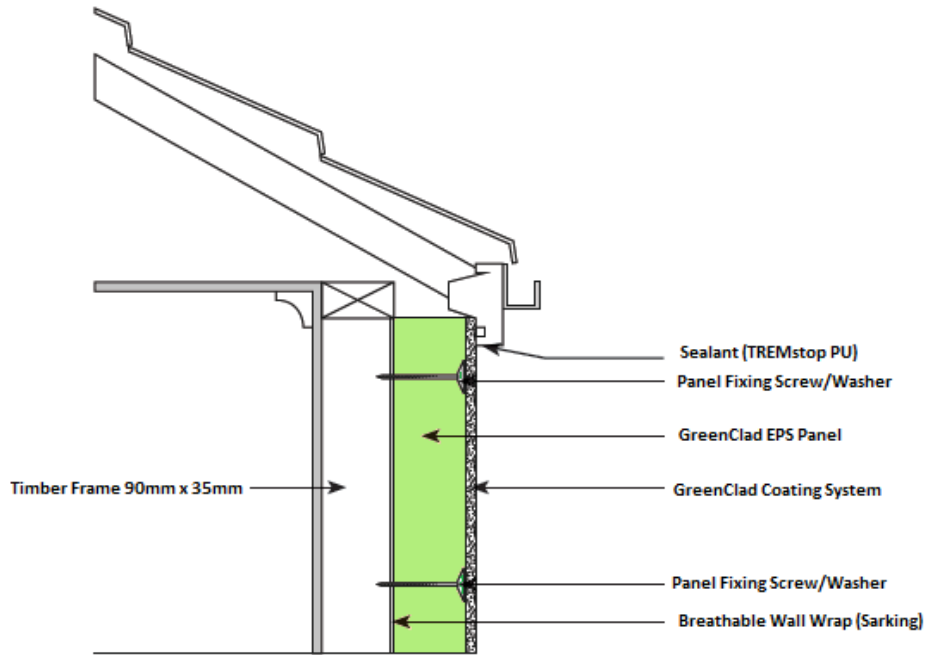

Parapet Detail

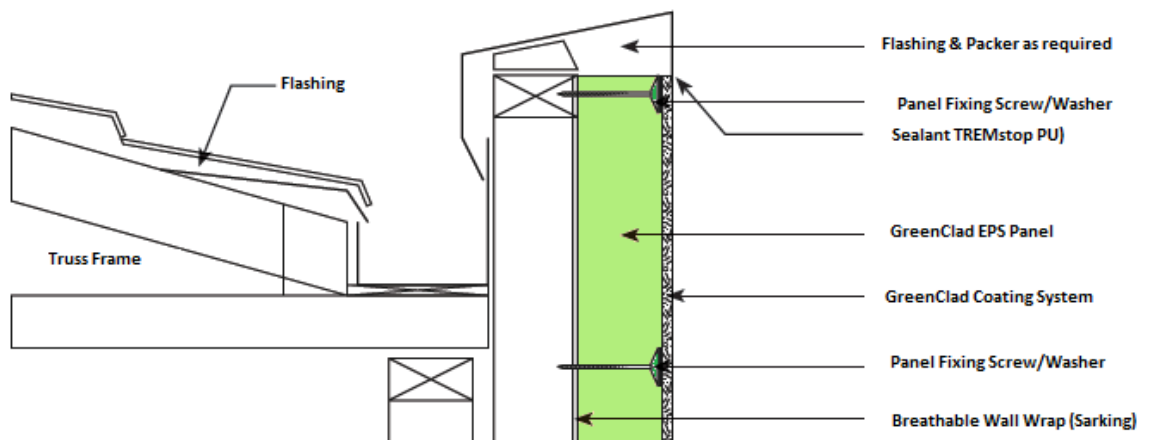

GreenClad INSULATED FAÇADE SYSTEM

Warranty

Painttex Pty Ltd (Painttex) warrants that the GreenClad system and products are free from any defects for a period of seven (7) years from date of application. For the avoidance of doubt this Warranty does not cover workmanship with respect to application of the GreenClad products. A material only replacement Warranty is provided on product performance only when the full complete recommended GreenClad system has been applied correctly by a skilled and experienced applicator using only GreenClad products supplied by Painttex and applied in accordance with instructions of use as specified in this manual at the time of application.

Important: To avail GreenClad System project warranty certificate, Installers /Builder should fill INSTALLATION CHECK LIST FOR CODEMARK™ CERTIFICATION form and submit to Painttex, forms are available from Painttex Sales.

Manufacturer's Comment

Painttex cannot accept responsibility for defects caused due to weather, substrate conditions, surface movement and wrong application methods. This product has been designed as part of a totally integrated application system. Use with any other manufacturers' product(s) or failing to follow application instructions as per GreenClad systems could result in detrimental effects on product performance, for which Painttex cannot be held responsible.

Disclaimer

The information contained in this manual is presented as a guide to users of GreenClad products, while to the best of Painttex's knowledge it is correct and reliable, no responsibility can be taken by the company for the applications in which GreenClad products may be selected or the way in which they are used.

PAINTTEX PTY LTD

Unit 4/10-12 South Link Dandenong South VIC 3175
P: (03) 9799 4044 F: (03) 9799 4066

